

## 1.6. DIMENSIONI DI INGOMBRO

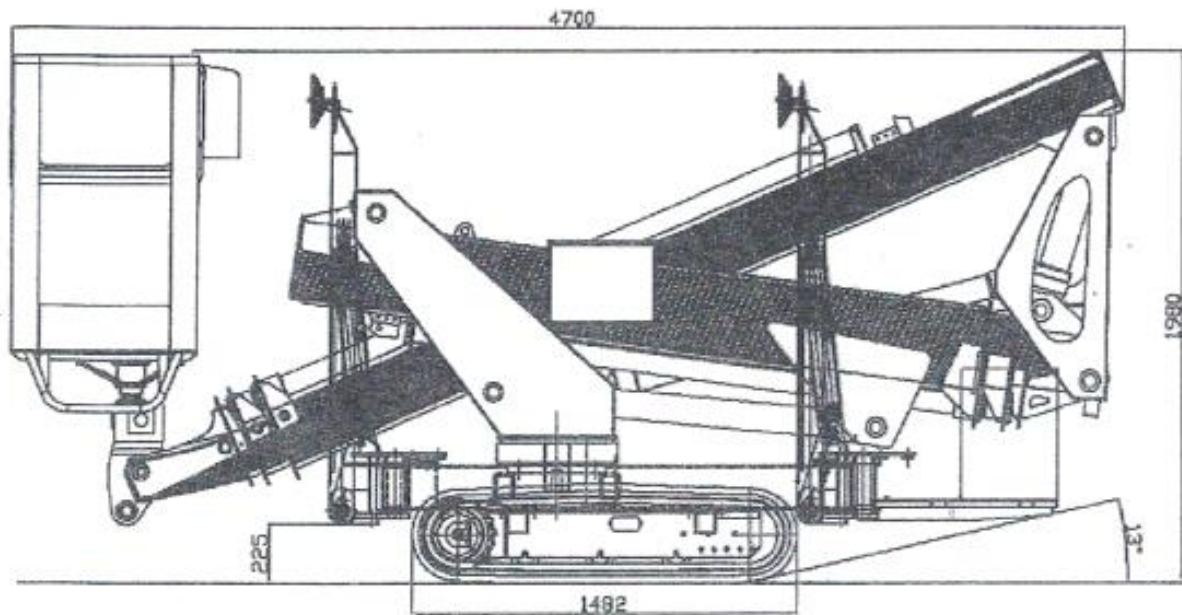
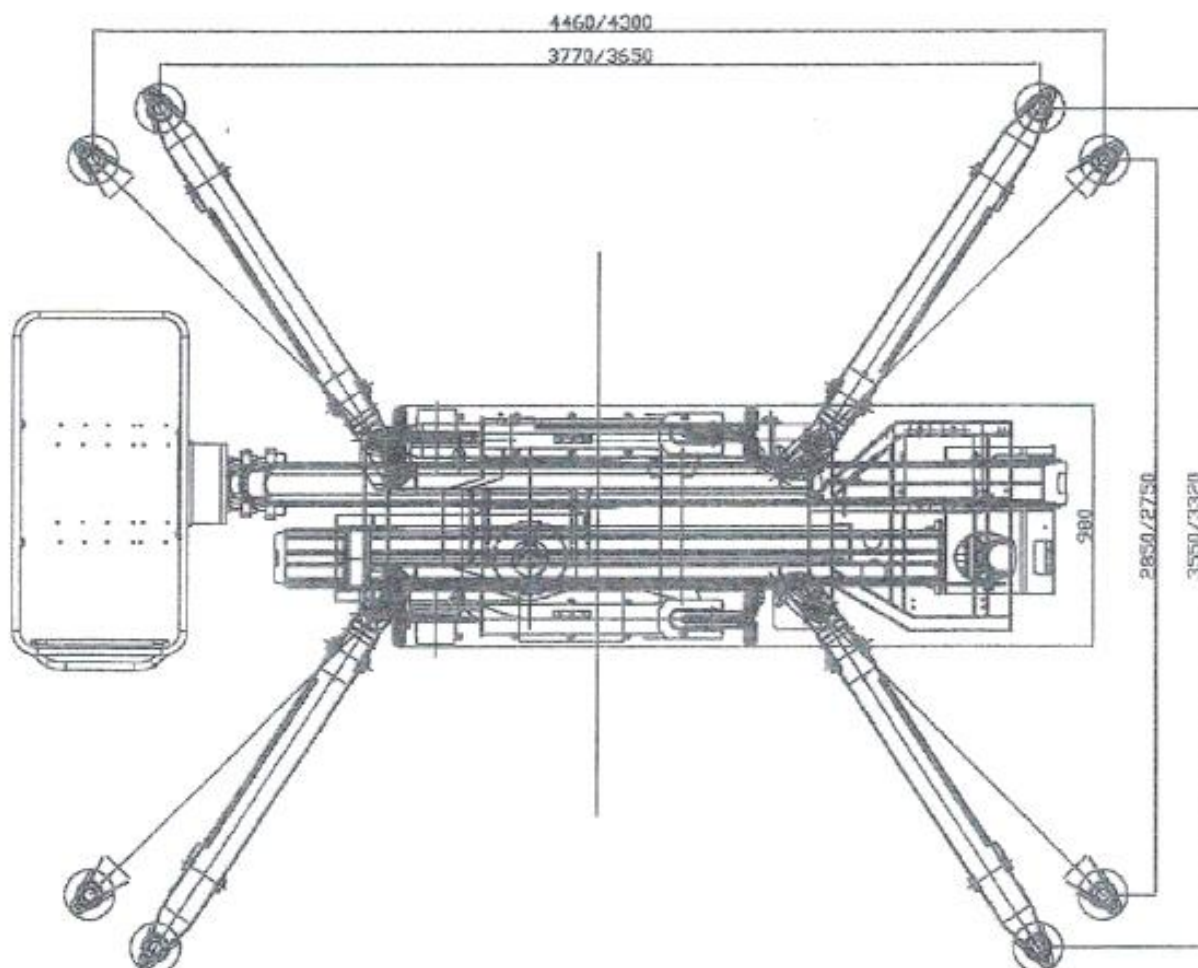
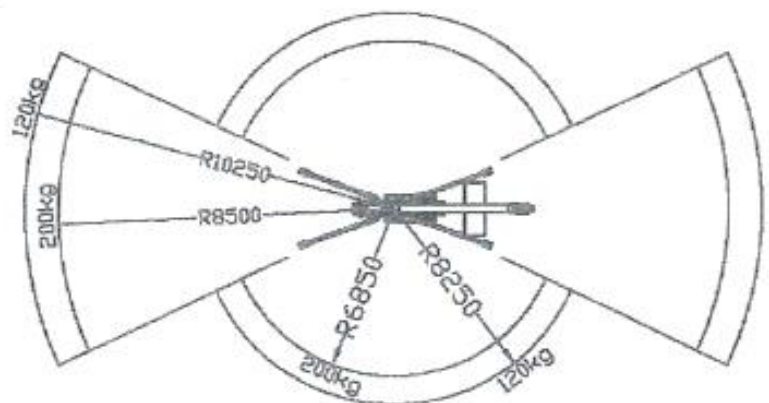
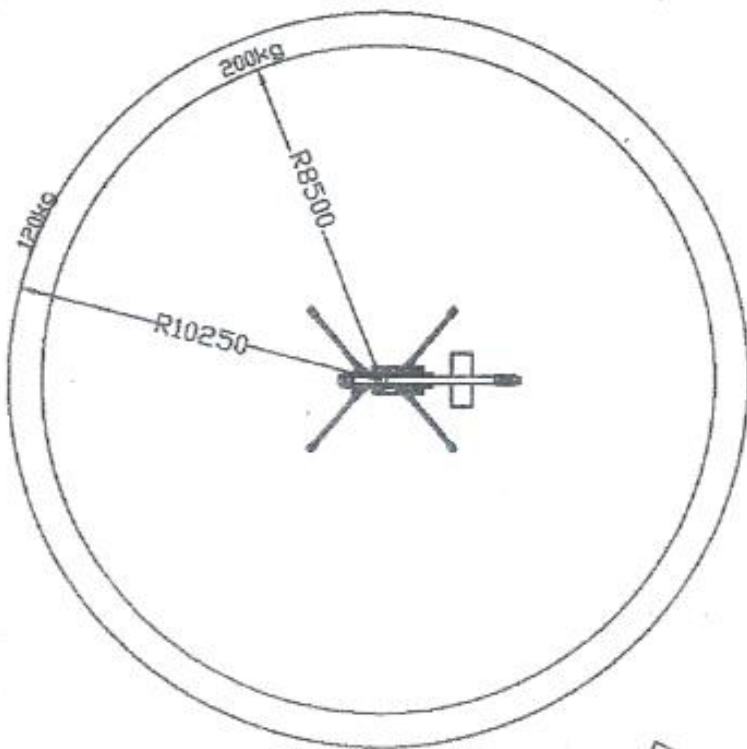
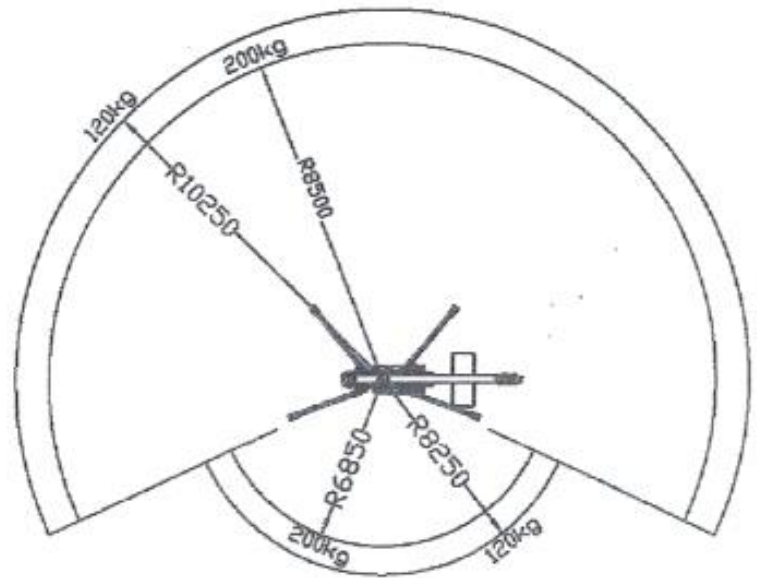

Fig. 1.1

Pressione specifica al suolo in traslazione  $0.45 \text{ kg/cm}^2$





## 1.7. DIAGRAMMA DI LAVORO

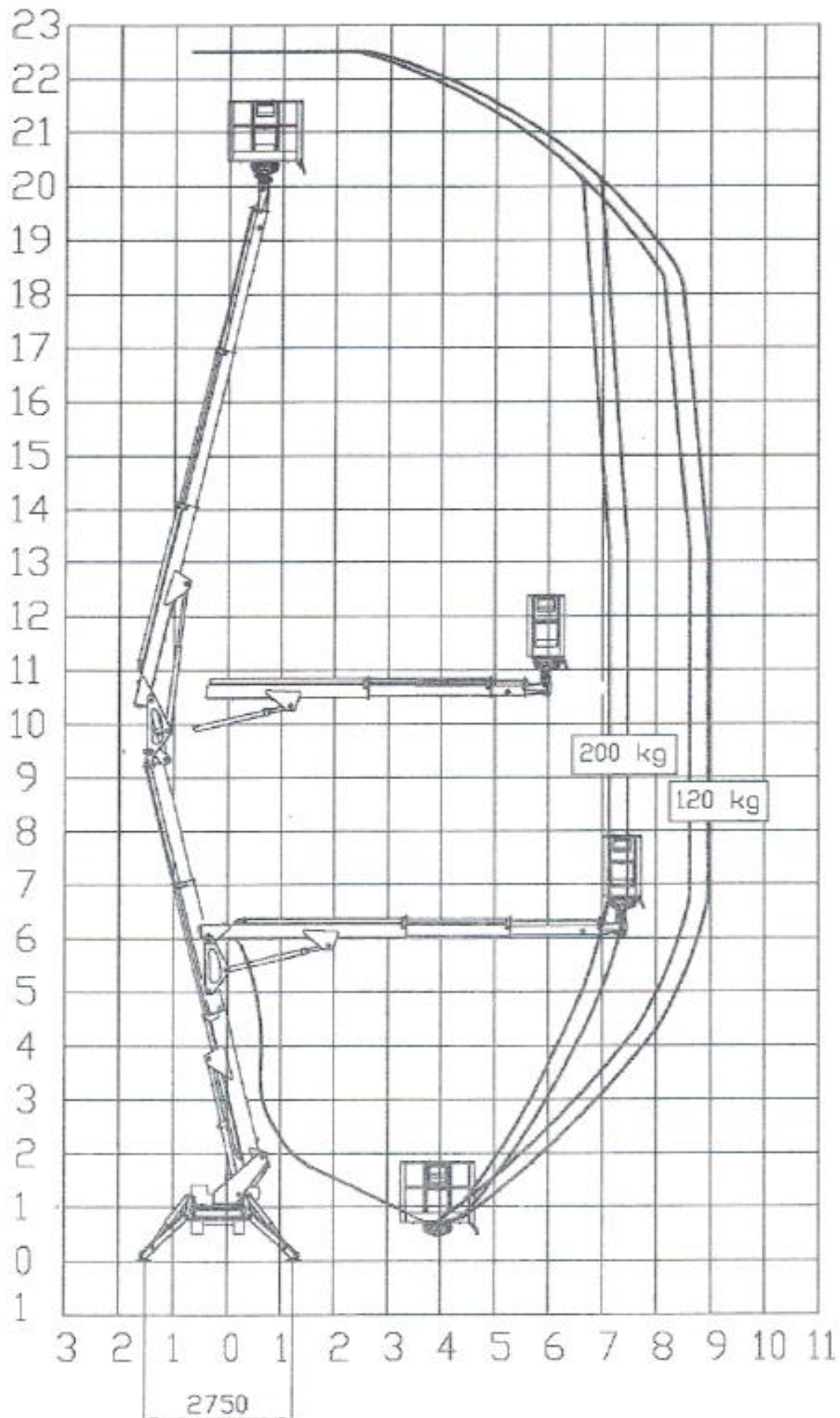

## A1 DIMENSIONI DI INGOMBRO

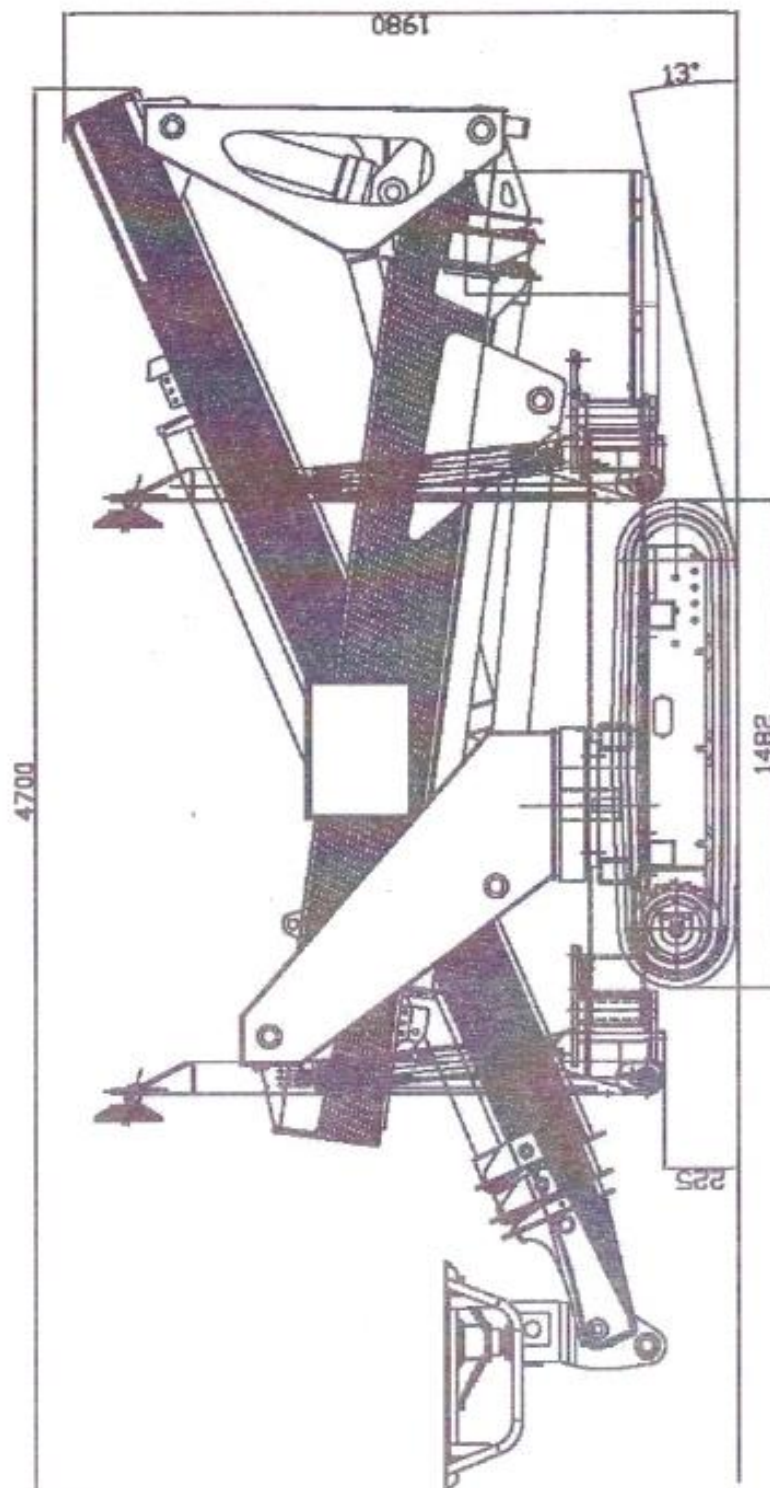

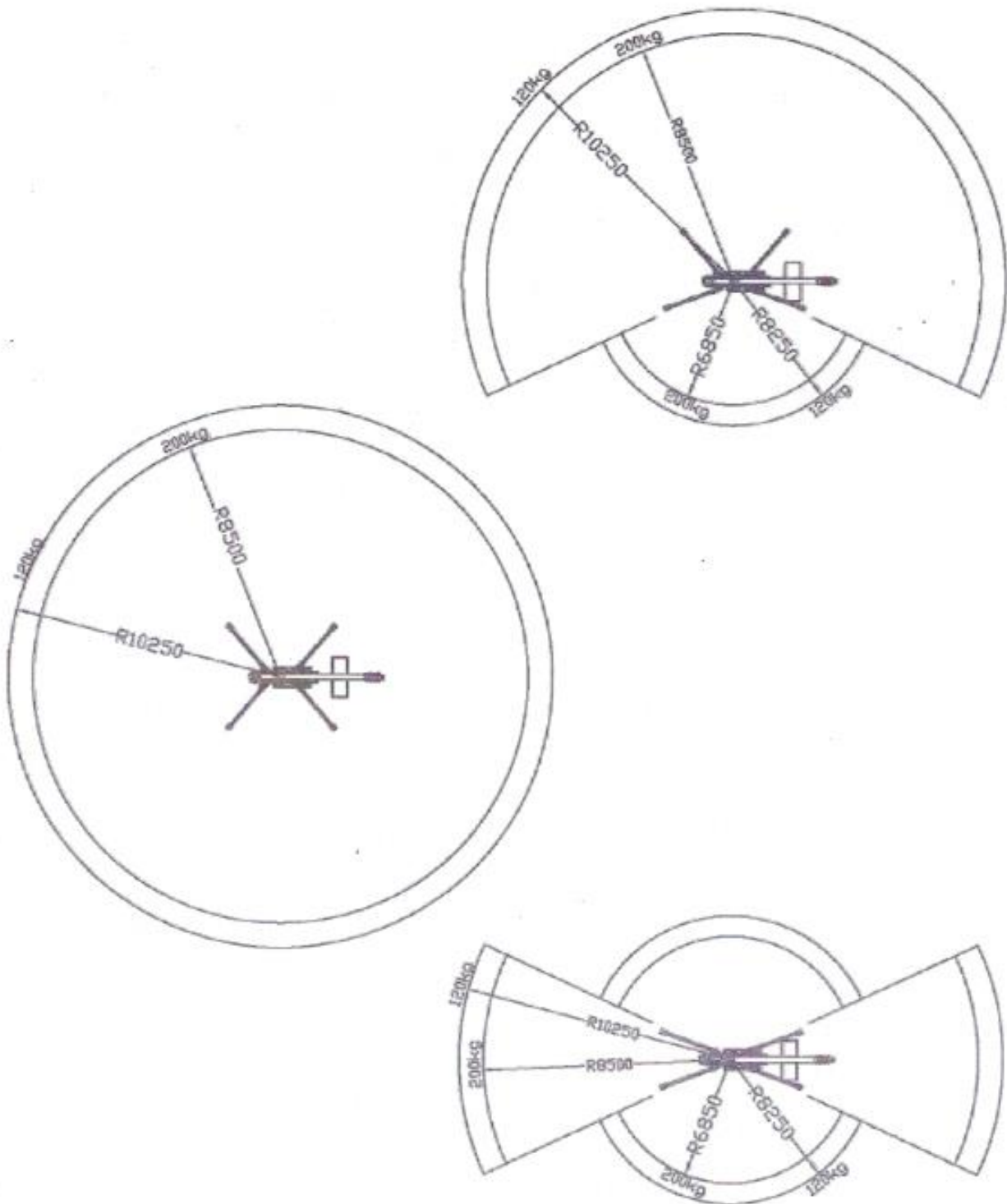

## A2 AREA DI LAVORO

